

PRODUCT INFORMATION SUMMARY

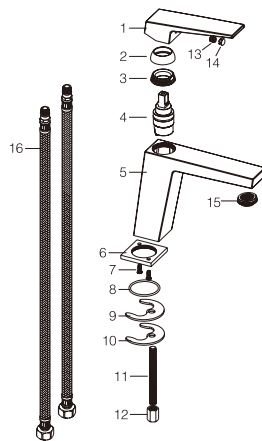

Ref.	EAN	Finish
BDAR025-1	8435668002448	Chrome
BDAR025-1BGM	8435668037754	Black gun metal
BDAR025-1NG	8435668002462	Matte black
BDAR025-1OC	8435668037761	Brushed gold
BDAR025-1BL	8435668002455	Matt white



CODE	NAME	MATERIAL	REF
1	handle	Zinc	
2	cover	ABS	
3	nut	brass	
4	cartridge	25mm up	CRT004*
5	body	brass	
6	base	brass	
7	screw	SUS304	
8	O-ring	NBR	
9	rubber washer	NBR	
10	metal washer	SUS304	
11	M8-screw	SUS304	
12	M8-nut	brass	
13	screw	SUS304	
14	cover	ABS	
15	aerator	M24X1mm	SAT-AIR072*
16	Connecting Pipe	TAQ-PEX-DN6-ACB H3/8-M10X1 L12-500-R&B	SAT-HOSE57*

* CONSULTAR PARA ACABADOS DE COLOR

Installing instruction

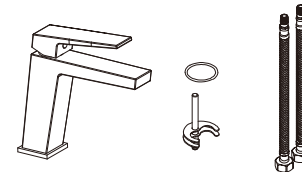

Step 1. Check all spare parts ready

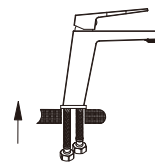

Step 2. Install inlet pipe to faucet body

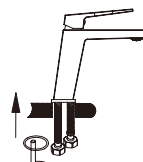

Step 3. Install screw stick to faucet body

Usage function instruction

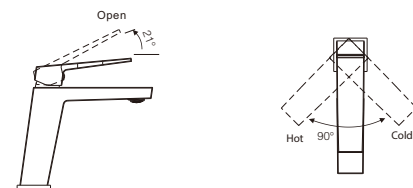

FLOW RATE

Detalles	
FLOW RATE REF	BDAR025-1
mixer water 0.1Mpa(L/MIN)	3.88
mixer water 0.3Mpa(L/MIN)	6.63
mixer water 0.5Mpa(L/MIN)	8.53
singer cold water 0.1Mpa(L/MIN)	3.9
singer cold water 0.3Mpa(L/MIN)	6.75
singer cold water 0.5Mpa(L/MIN)	8.64

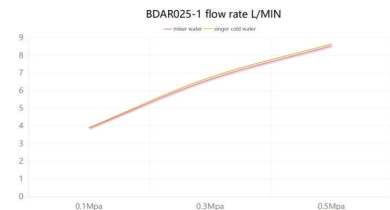
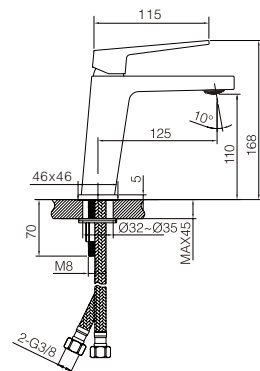

Product sizes (cm)	30*21*5.9
Weight (kg)	1.25
Guarantee	5 years
Max Preasure (bar)	5
Min Preasure (bar)	0.5
Optimum preasure (bar)	1-4 (Recommended 3)
Max. temperature	85°C
Min temperature	65°C

CERTIFIES

That all our products, provided that they are used in normal conditions or installed in accordance with current standards, are guaranteed against any manufacturing defect for a period of five years, except for products purchased before January 1, 2020, which will have the mandatory coverage of 2 years from the date of invoice.

Requirements and exclusions

Failure to comply with the instructions for assembly, use and maintenance of our products on the packaging and in our catalogue and published on our website: www.imexproducts.es, releases IMEX PRODUCTS, S.L. from any liability.

In any case, the acceptance of the defect by our technical department is necessary. In addition, transport costs will be charged only in the event that on IMEX PRODUCTS, S.L. technician determines the proper functioning of our products.

IMEX PRODUCTS, S.L. will decide to repair the product or replace it. It will be necessary to present the purchase invoice.

Assembly, maintenance or repairs carried out by non-specialists are excluded from the warranty.

Wearing parts such as hoses, handles, seals, filters, aerators, etc. are not covered by the warranty.



PRODUCT INFORMATION SUMMARY



Ref.	EAN	Finish
BDAR025-2	8435668002479	Chrome
BDAR025-2BGM	8435668037778	Black gun metal
BDAR025-2NG	8435668002493	Matte black
BDAR025-2OC	8435668037785	Brushed gold
BDAR025-2BL	8435668002486	Matt white

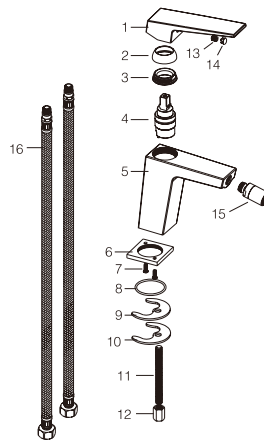

CODE	NAME	MATERIAL	REF
1	handle	Zinc	
2	cover	ABS	
3	nut	brass	
4	cartridge	25mm up	CRT004*
5	body	brass	
6	base	brass	
7	screw	SUS304	
8	O-ring	NBR	
9	rubber washer	NBR	
10	metal washer	SUS304	
11	M8-screw	SUS304	
12	M8-nut	brass	
13	screw	SUS304	
14	cover	ABS	
15	aerator	22mm	SAT-AIR02*
16	Connecting Pipe	TAQ-PEX-DN6-ACB H3/8-M10X1 L12-500-R&B	SAT-HOSES7*

* CONSULTAR PARA ACABADOS DE COLOR

Installing instruction

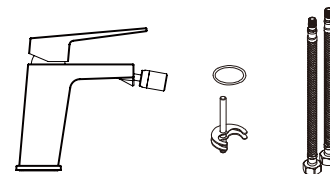

Step 1. Check all spare parts ready

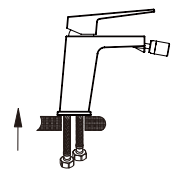

Step 2. Install inlet pipe to faucet body

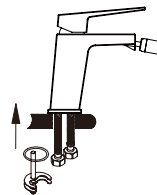

Step 3. Install screw stick to faucet body

Usage function instruction

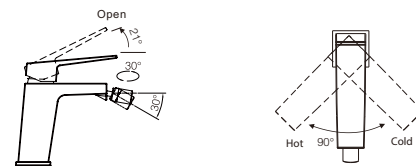

FLOW RATE

Detalles	
FLOW RATE REF	BDAR025-2
mixer water 0.1Mpa(L/MIN)	6.84
mixer water 0.3Mpa(L/MIN)	11.69
mixer water 0.5Mpa(L/MIN)	15.08
singer cold water 0.1Mpa(L/MIN)	6.7
singer cold water 0.3Mpa(L/MIN)	11.58
singer cold water 0.5Mpa(L/MIN)	14.64

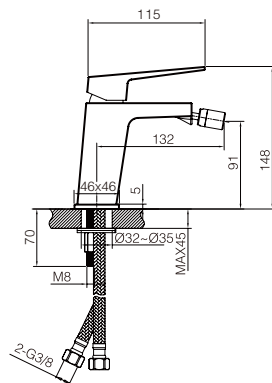
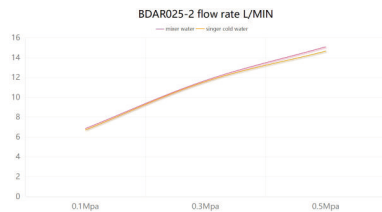

Product sizes (cm)	26.7*18.1*5.9
Weight (kg)	1.2
Guarantee	5 years
Max Preasure (bar)	5
Min Preasure (bar)	0.5
Optimum preasure (bar)	1-4 (Recommended 3)
Max. temperature	85°C
Min temperature	65°C

CERTIFIES

That all our products, provided that they are used in normal conditions or installed in accordance with current standards, are guaranteed against any manufacturing defect for a period of five years, except for products purchased before January 1, 2020, which will have the mandatory coverage of 2 years from the date of invoice.

Requirements and exclusions

Failure to comply with the instructions for assembly, use and maintenance of our products on the packaging and in our catalogue and published on our website: www.imexproducts.es, releases IMEX PRODUCTS, S.L. from any liability.

In any case, the acceptance of the defect by our technical department is necessary. In addition, transport costs will be charged only in the event that on IMEX PRODUCTS, S.L. technician determines the proper functioning of our products.

IMEX PRODUCTS, S.L. will decide to repair the product or replace it. It will be necessary to present the purchase invoice.

Assembly, maintenance or repairs carried out by non-specoalists re excluded from the warranty.

Wearing parts such as hoses, handles, seals, filters, aerators, etc. are not covered by the warranty.



**PRODUCT
INFORMATION
SUMMARY**



Ref.	EAN	Finish
BDAR025-3	8435668002509	Chrome
BDAR025-3BGM	8435668037792	Black gun metal
BDAR025-3NG	8435668002523	Matte black
BDAR025-3OC	8435668037808	Brushed gold
BDAR025-3BL	8435668002516	Matt white

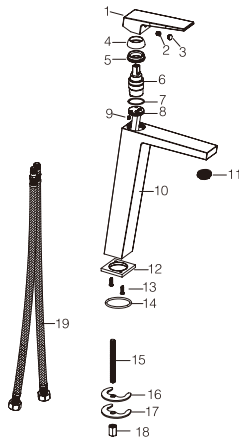

CODE	NAME	MATERIAL	REF
1	handle	Zinc	
2	screw	SUS304	
3	cover	ABS	
4	cover	ABS	
5	nut	brass	
6	cartridge	25mm up	CRT004*
7	O-ring	NBR	
8	cartridge base	brass	
9	screw	SUS304	
10	body	brass	
11	aerator	M24X1mm	SAT-AIR072*
12	base	brass	
13	screw	SUS304	
14	O-ring	NBR	
15	M8-screw	SUS304	
16	Rubber washer	NBR	
17	metal washer	SUS304	
18	M8 nut	brass	
19	Connecting Pipe	TAQ-PEX-DN6-ACB H3/8-M10X1 L12-500-R&B	SAT-HOSES7*

* CONSULTAR PARA ACABADOS DE COLOR

Installing instruction

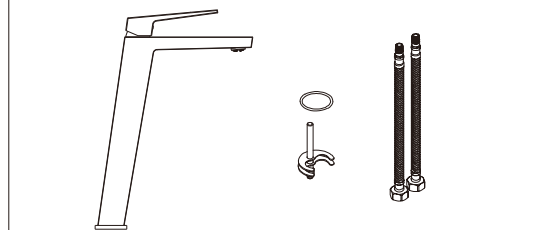

Step 1. Check all spare parts ready

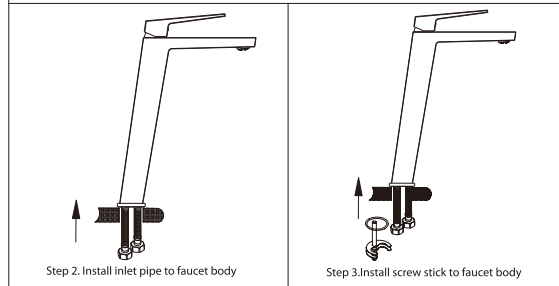

Step 2. Install inlet pipe to faucet body

Step 3. Install screw stick to faucet body

Usage function instruction

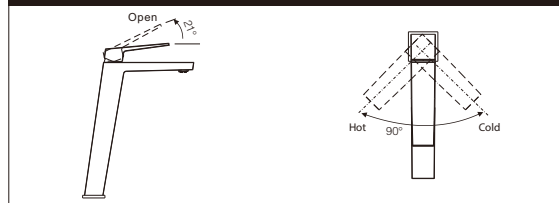

FLOW RATE

Detalles	
FLOW RATE REF	BDAR025-3
mixer water 0.1Mpa(L/MIN)	3.42
mixer water 0.3Mpa(L/MIN)	5.77
mixer water 0.5Mpa(L/MIN)	7.46
singer cold water 0.1Mpa(L/MIN)	2.27
singer cold water 0.3Mpa(L/MIN)	3.89
singer cold water 0.5Mpa(L/MIN)	5.03

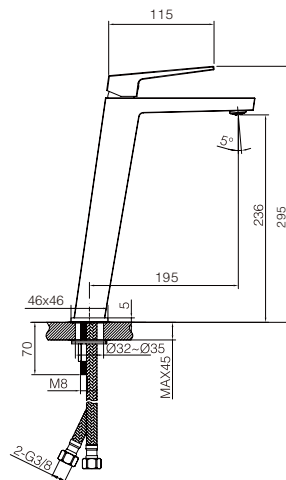
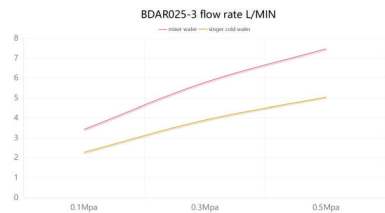

Product sizes (cm)	39*21*5.9
Weight (kg)	1.8
Guarantee	5 years
Max Preasure (bar)	5
Min Preasure (bar)	0.5
Optimum preasure (bar)	1-4 (Recommended 3)
Max. temperature	85°C
Min temperature	65°C

CERTIFIES

That all our products, provided that they are used in normal conditions or installed in accordance with current standards, are guaranteed against any manufacturing defect for a period of five years, except for products purchased before January 1, 2020, which will have the mandatory coverage of 2 years from the date of invoice.

Requirements and exclusions

Failure to comply with the instructions for assembly, use and maintenance of our products on the packaging and in our catalogue and published on our website: www.imexproducts.es, releases IMEX PRODUCTS, S.L. from any liability.

In any case, the acceptance of the defect by our technical department is necessary. In addition, transport costs will be charged only in the event that on IMEX PRODUCTS, S.L. technician determines the proper functioning of our products.

IMEX PRODUCTS, S.L. will decide to repair the product or replace it. It will be necessary to present the purchase invoice.

Assembly, maintenance or repairs carried out by non-specoalists re excluded from the warranty.

Wearing parts such as hoses, handles, seals, filters, aerators, etc. are not covered by the warranty.



PRODUCT INFORMATION SUMMARY



Ref.	EAN	Finish
BDAR025	8435668002431	Chrome
BDAR025-BGM	8435668037730	Black gun metal
BDAR025-NG	8435668002547	Matte black
BDAR025-OC	8435668037747	Brushed gold
BDAR025-BL	8435668002530	Matt white

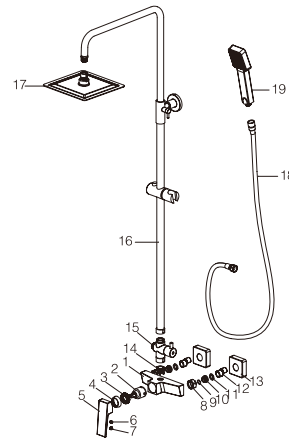

CODE	NAME	MATERIAL	REF	CODE	NAME	MATERIAL	REF
1	body	brass		16	pipe	SUS 304	RR001*
2	cartridge	35mm	CRT001*	17	shower head	SUS 304	RDC001*
3	nut	brass		18	hose	SUS 304 / PVC	FLX005*
4	cover	ABS		19	shower hand	ABS	MDDR001*
5	handle	Zinc					
6	screw	SUS 304					
7	cover	ABS					
8	nut	brass					
9	O-ring	NBR					
10	screw	SUS 304					
11	rubber	NBR					
12	cabrio leg	SUS 304					
13	cover	SUS 304					
14	connect	brass					
15	diverter	brass					

* CONSULTAR PARA ACABADOS DE COLOR

shower set installing instruction

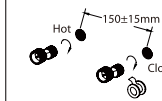

Step 1. Connect curved leg with the inlet pipe inside the wall

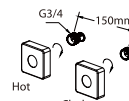

Step 2. Connect decorative cover to curved leg



Step 3. Install shower faucet properly and connect to curved leg on the wall



Step 4. Install shower pipe according to the distance of fix part

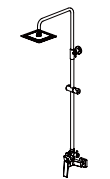

Step 5. Install shower hand and shower head to the set



Step 6. Test function of shower set, clean the set

Usage function instruction

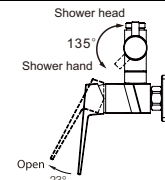
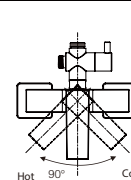

FLOW RATE

Detalles	
FLOW RATE REF	BDAR025
hand shower mixer water 0.1Mpa(L/MIN)	6.2
hand shower mixer water 0.3Mpa(L/MIN)	11.34
hand shower mixer water 0.5Mpa(L/MIN)	15.23
hand shower singer cold water 0.1Mpa(L/MIN)	6.16
hand shower singer cold water 0.3Mpa(L/MIN)	11.19
hand shower singer cold water 0.5Mpa(L/MIN)	15.06
shower head mixer water 0.1Mpa(L/MIN)	6.23
shower head mixer water 0.3Mpa(L/MIN)	11.24
shower head mixer water 0.5Mpa(L/MIN)	14.9
shower head singer cold water 0.1Mpa(L/MIN)	6.19
shower head singer cold water 0.3Mpa(L/MIN)	11.12
shower head singer cold water 0.5Mpa(L/MIN)	14.81

hand shower

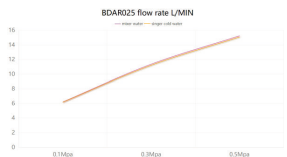

shower head

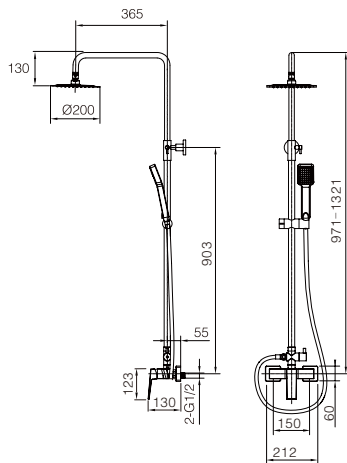
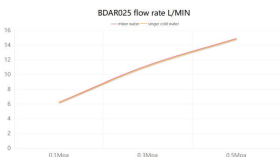

Product sizes (cm)	42.5*13.3*90
Weight (kg)	5.5
Guarantee	5 years
Max Preassure (bar)	5
Min Preassure (bar)	0.5
Optimum preassure (bar)	1-4 (Recommended 3)
Max. temperature	85°C
Min temperature	65°C

CERTIFIES

That all our products, provided that they are used in normal conditions or installed in accordance with current standards, are guaranteed against any manufacturing defect for a period of five years, except for products purchased before January 1, 2020, which will have the mandatory coverage of 2 years from the date of invoice.

Requirements and exclusions

Failure to comply with the instructions for assembly, use and maintenance of our products on the packaging and in our catalogue and published on our website: www.imexproducts.es, releases IMEX PRODUCTS, S.L. from any liability.

In any case, the acceptance of the defect by our technical department is necessary. In addition, transport costs will be charged only in the event that on IMEX PRODUCTS, S.L. technician determines the proper functioning of our products.

IMEX PRODUCTS, S.L. will decide to repair the product or replace it. It will be necessary to present the purchase invoice.

Assembly, maintenance or repairs carried out by non-specialists are excluded from the warranty.

Wearing parts such as hoses, handles, seals, filters, aerators, etc. are not covered by the warranty.



PRODUCT INFORMATION SUMMARY

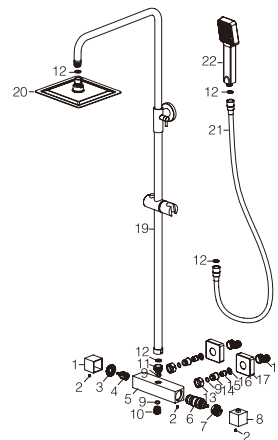

Ref.	EAN	Finish
BTAR025	8435668037990	Chrome
BTAR025-BGM	8435668038003	Black gun metal
BTAR025-NG	8435668038027	Matte black
BTAR025-OC	8435668038034	Brushed gold
BTAR025-BL	8435668038010	Matt white

CODE	NAME	MATERIAL	REF	CODE	NAME	MATERIAL	REF
1	Handle	zinc		16	washer	NBR	
2	screw	SUS 304		17	cover	SUS 304	
3	Nut	Brass		18	Cabrio leg	SUS 304	
4	Cartridge	31mm		19	pipe	SUS 304	
5	body	Brass		20	Shower head	SUS 304	RDC001*
6	Cartridge	32mm	CRT012*	21	Hose	SUS 304 / PVC	FLX005*
7	Connect	Brass		22	Shower hand	ABS	MDDR001*
8	handle	zinc					
9	O-ring	NBR					
10	Connect	Brass					
11	Connect	Brass					
12	washwer	NBR					
13	nut	Brass					
14	screw	SUS 304					
15	valve	ABS					

* CONSULTAR PARA ACABADOS DE COLOR

shower set installing instruction

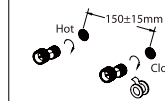

Step 1. Connect curved leg with the inlet pipe inside the wall

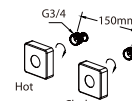

Step 2. Connect decorative cover to curved leg

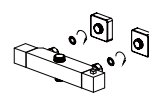

Step 3. Install shower faucet properly and connect to curved leg on the wall

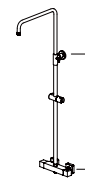

Step 4. Install shower pipe according to the distance of fix part

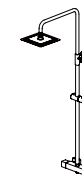

Step 5. Install shower hand and shower head to the set



Step 6. Test function of shower set, clean the set

Usage function instruction

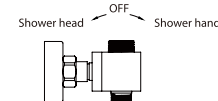
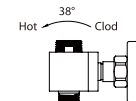

FLOW RATE

Detalles	
FLOW RATE REF	BTAR025
hand shower mixer water 0.1Mpa(L/MIN)	6.45
hand shower mixer water 0.3Mpa(L/MIN)	12.03
hand shower mixer water 0.5Mpa(L/MIN)	16.48
hand shower singer cold water 0.1Mpa(L/MIN)	6.36
hand shower singer cold water 0.3Mpa(L/MIN)	11.71
hand shower singer cold water 0.5Mpa(L/MIN)	15.88
shower head mixer water 0.1Mpa(L/MIN)	6.86
shower head mixer water 0.3Mpa(L/MIN)	12.68
shower head mixer water 0.5Mpa(L/MIN)	16.99
shower head singer cold water 0.1Mpa(L/MIN)	6.75
shower head singer cold water 0.3Mpa(L/MIN)	12.37
shower head singer cold water 0.5Mpa(L/MIN)	16.54

hand shower

shower head

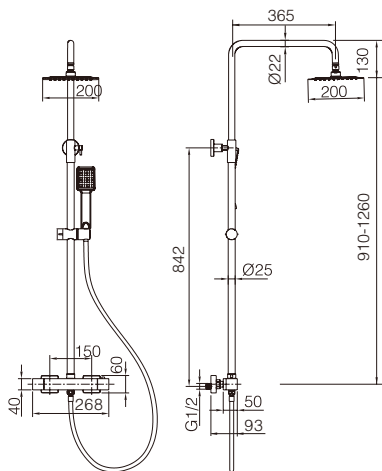
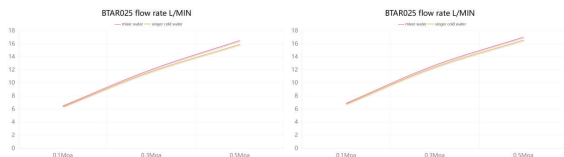

Product sizes (cm)	42.5*13.3*90
Weight (kg)	6
Guarantee	5 years
Max Preassure (bar)	5
Min Preassure (bar)	0.5
Optimum preassure (bar)	1-4 (Recommended 3)
Max. temperature	85°C
Min temperature	65°C

CERTIFIES

That all our products, provided that they are used in normal conditions or installed in accordance with current standards, are guaranteed against any manufacturing defect for a period of five years, except for products purchased before January 1, 2020, which will have the mandatory coverage of 2 years from the date of invoice.

Requirements and exclusions

Failure to comply with the instructions for assembly, use and maintenance of our products on the packaging and in our catalogue and published on our website: www.imexproducts.es, releases IMEX PRODUCTS, S.L. from any liability.

In any case, the acceptance of the defect by our technical department is necessary. In addition, transport costs will be charged only in the event that on IMEX PRODUCTS, S.L. technician determines the proper functioning of our products.

IMEX PRODUCTS, S.L. will decide to repair the product or replace it. It will be necessary to present the purchase invoice.

Assembly, maintenance or repairs carried out by non-specialists are excluded from the warranty.

Wearing parts such as hoses, handles, seals, filters, aerators, etc. are not covered by the warranty.



PRODUCT INFORMATION SUMMARY



Ref.	EAN	Finish
BDAR025-4	8435668037815	Chrome
BDAR025-4BGM	8435668037822	Black gun metal
BDAR025-4NG	8435668037846	Matte black
BDAR025-4OC	8435668037853	Brushed gold
BDAR025-4BL	8435668037839	Matt white

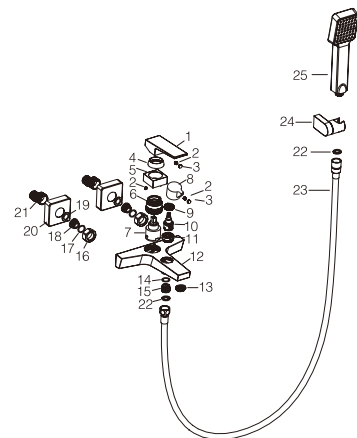

CODE	NAME	MATERIAL	REF	CODE	NAME	MATERIAL	REF
1	Handle	zinc		20	rubber	NBR	
2	screw	SUS 304		21	Cabrio leg	SUS 304	
3	button	ABS		22	rubber	NBR	
4	decorative cover	ABS		23	hose	SUS 304 / PVC	FLX010*
5	decorative base	Brass		24	shower seat	ABS	SMD007*
6	nut	brass		25	shower hand	ABS	MDL001*
7	Cartridge	35mm	CRT006*				
8	Handle	zinc					
9	nut	Brass					
10	Cartridge	22mm					
11	connect	Brass					
12	body	Brass					
13	aerator	24X1mm	SAT-AIR019*				
14	O-ring	NBR					
15	connect	Brass					
16	Nut	Brass					
17	O-ring	NBR					
18	Screw	SUS 304					
19	Cover	SUS 304					

* CONSULTAR PARA ACABADOS DE COLOR

shower set installing instruction

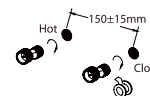

Step 1. Connect curved leg with the inlet pipe inside the wall

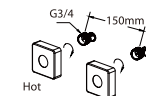

Step 2. Connect decorative cover to curved leg

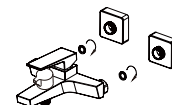

Step 3. Install shower faucet properly, and connect to curved leg on the wall

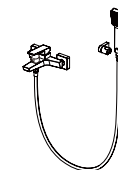

Step 4. Test function of shower set, clean the set

Useage function instruction

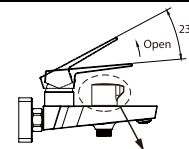
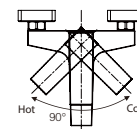

WATER FAUCET 180° SHOWER HAND

FLOW RATE

Detailles	
FLOW RATE REF	BDAR025-4
water outlet mixer water 0.1Mpa(L/MIN)	5
water outlet mixer water 0.3Mpa(L/MIN)	8.6
water outlet mixer water 0.5Mpa(L/MIN)	11.08
water outlet singer cold water 0.1Mpa(L/MIN)	5
water outlet singer cold water 0.3Mpa(L/MIN)	8.53
water outlet singer cold water 0.5Mpa(L/MIN)	10.98
hand shower mixer water 0.1Mpa(L/MIN)	6.42
hand shower mixer water 0.3Mpa(L/MIN)	11.68
hand shower mixer water 0.5Mpa(L/MIN)	15.75
hand shower singer cold water 0.1Mpa(L/MIN)	6.36
hand shower singer cold water 0.3Mpa(L/MIN)	11.55
hand shower singer cold water 0.5Mpa(L/MIN)	15.58

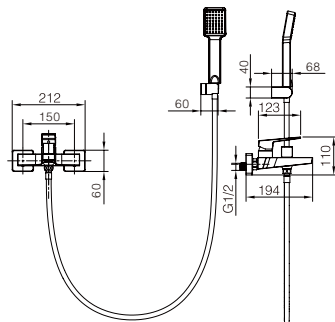

Product sizes (cm)	21.5*18*14
Weight (kg)	2.3
Guarantee	5 years
Max Preassure (bar)	5
Min Preassure (bar)	0.5
Optimum preassure (bar)	1-4 (Recommended 3)
Max. temperature	85°C
Min temperature	65°C

CERTIFIES

That all our products, provided that they are used in normal conditions or installed in accordance with current standards, are guaranteed against any manufacturing defect for a period of five years, except for products purchased before January 1, 2020, which will have the mandatory coverage of 2 years from the date of invoice.

Requirements and exclusions

Failure to comply with the instructions for assembly, use and maintenance of our products on the packaging and in our catalogue and published on our website: www.imexproducts.es, releases IMEX PRODUCTS, S.L. from any liability.

In any case, the acceptance of the defect by our technical department is necessary. In addition, transport costs will be charged only in the event that on IMEX PRODUCTS, S.L. technician determines the proper functioning of our products.

IMEX PRODUCTS, S.L. will decide to repair the product or replace it. It will be necessary to present the purchase invoice.

Assembly, maintenance or repairs carried out by non-specialists are excluded from the warranty.

Wearing parts such as hoses, handles, seals, filters, aerators, etc. are not covered by the warranty.



PRODUCT INFORMATION SUMMARY

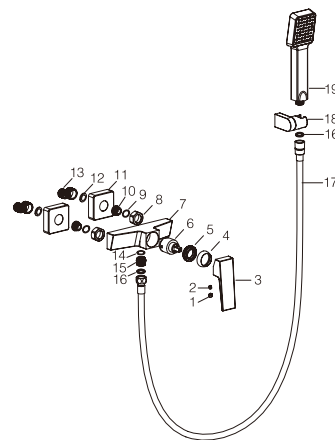

Ref.	EAN	Finish
BDAR025-5	8435668037860	Chrome
BDAR025-5BGM	8435668037877	Black gun metal
BDAR025-5NG	8435668037891	Matte black
BDAR025-SOC	8435668037907	Brushed gold
BDAR025-SBL	8435668037884	Matt white

CODE	NAME	MATERIAL	REF
1	button	ABS	
2	screw	SUS 304	
3	handle	zinc	
4	decorative cover	ABS	
5	nut	Brass	CRT006*
6	Cartridge	35mm	
7	body	brass	
8	nut	brass	
9	O-ring	NBR	
10	screw	SUS 304	
11	cover	SUS 304	
12	rubber	NBR	
13	Cartridge leg	SUS 304	
14	O-ring	NBR	
15	connect	Brass	
16	rubber	NBR	
17	hose	SUS 304 / PVC	FLX005*
18	Shower seat	ABS	SMD007*
19	Shower hand	ABS	MDL001*

* CONSULTAR PARA ACABADOS DE COLOR

shower set installing instruction

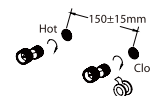

Step 1. Connect curved leg with the inlet pipe inside the wall

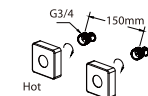

Step 2. Connect decorative cover to curved leg

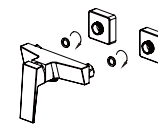

Step 3. Install shower faucet properly, and connect to curved leg on the wall

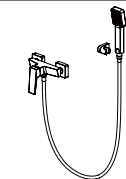

Step 4. Test function of shower set, clean the set

Usage function instruction

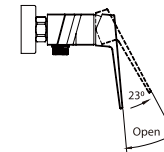
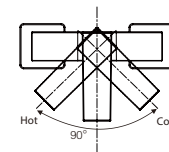

FLOW RATE

Detalles	
FLOW RATE REF	BDAR025-5
mixer water 0.1Mpa(L/MIN)	6.7
mixer water 0.3Mpa(L/MIN)	12.4
mixer water 0.5Mpa(L/MIN)	16.95
singer cold water 0.1Mpa(L/MIN)	6.6
singer cold water 0.3Mpa(L/MIN)	12.2
singer cold water 0.5Mpa(L/MIN)	16.6

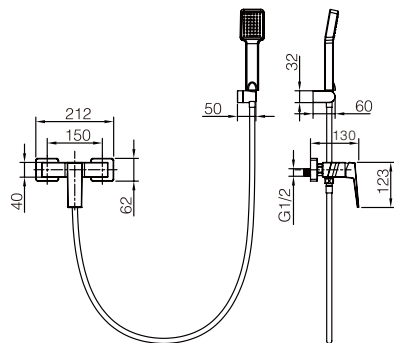
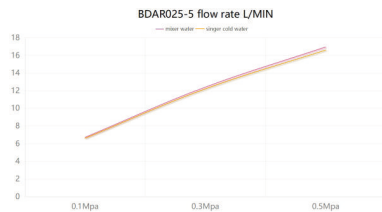

Product sizes (cm)	21.5*18*14
Weight (kg)	2.3
Guarantee	5 years
Max Preasure (bar)	5
Min Preasure (bar)	0.5
Optimum preasure (bar)	1-4 (Recommended 3)
Max. temperature	85°C
Min temperature	65°C

CERTIFIES

That all our products, provided that they are used in normal conditions or installed in accordance with current standards, are guaranteed against any manufacturing defect for a period of five years, except for products purchased before January 1, 2020, which will have the mandatory coverage of 2 years from the date of invoice.

Requirements and exclusions

Failure to comply with the instructions for assembly, use and maintenance of our products on the packaging and in our catalogue and published on our website: www.imexproducts.es, releases IMEX PRODUCTS, S.L. from any liability.

In any case, the acceptance of the defect by our technical department is necessary. In addition, transport costs will be charged only in the event that on IMEX PRODUCTS, S.L. technician determines the proper functioning of our products.

IMEX PRODUCTS, S.L. will decide to repair the product or replace it. It will be necessary to present the purchase invoice.

Assembly, maintenance or repairs carried out by non-specialists are excluded from the warranty.

Wearing parts such as hoses, handles, seals, filters, aerators, etc. are not covered by the warranty.

